

the ECONO-LOC *Eccentric Actuated Expansion Collet*



PATENT PENDING

The Econo-Loc expanding collet is an ideal way to hold parts internally when you do not have a collet fixture or actuator on a lathe or mill. The expanding collet is manually operated by simply turning the socket head eccentric cam, which pushes a tapered plunger inside the collet causing it to expand. This design is ideal for blind hole parts, because there is not an expanding screw in front of the collet. In addition, the collet is dead length which is a must for holding linear dimensions consistently.

The tool can be used in turning operations as well as milling operations. Simply locate on the shank of the Econo-Loc and turn the collet to your desired diameter. Included with the collet is a locking ring that allows for a rigid set-up when turning the collet to your desired size. The machineable range of the collet is 2.093 inches to .690 inches. Available with 1-1/2 inch or 1 inch shank.

Unique cam and plunger design creates tremendous I.D. clamping force

Exclusive Set Cut Locking Ring provides accurate preset diameter and rigidity when turning collet to desired size

Ideal for parts with blind holes and where dead length is needed

For use on mills or lathes

For bore diameters from .690" to 2.093"

For quick set-ups when collet systems are not available

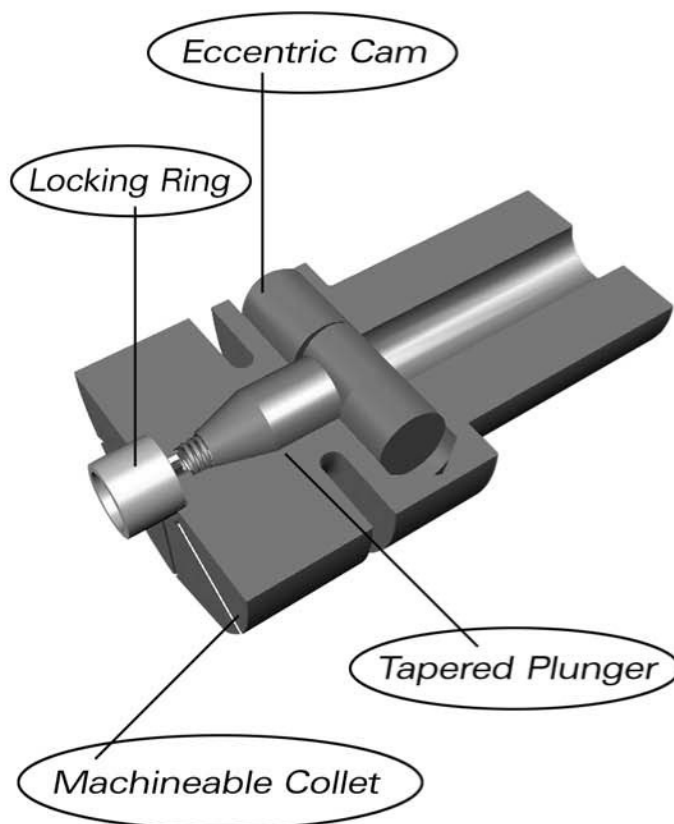

Part#
Econo-Loc-1 1" Diameter Shank \$143.00